

MILLER'S

Presentation Furniture



Instructor Series 36" - Level 2
Data Sheet



MILLER'S

Presentation Furniture

Dimensions

36" W x 30" D x 48" H

Rackspace: 16RU Front & 16RU Rear

Technical Specifications

1	Flat Worksurface made of P-Lam
2	Cable Grommits in Worksurface
3	Hardwood Pencil Lip
4	Sliding Keyboard/Mouse Shelf
5	Hinged Locking Doors
6	Locking Removable Access Panel

Top

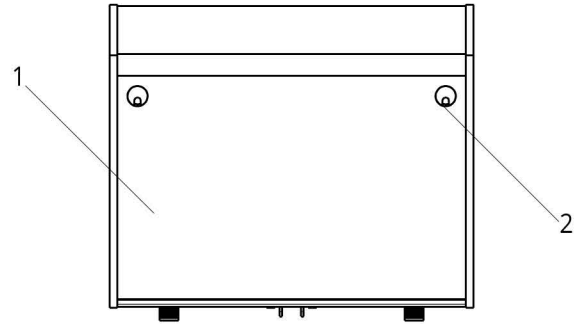

Front

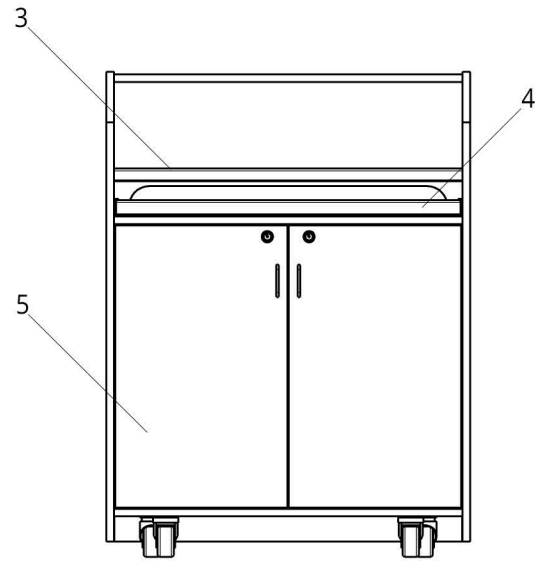

Back

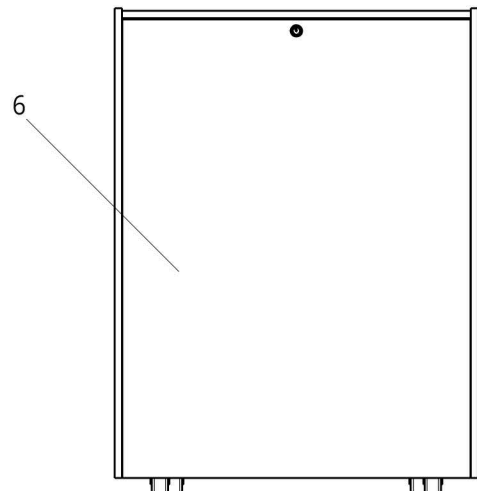



MILLER'S

Presentation Furniture

Isometric View (Hidden lines shown)

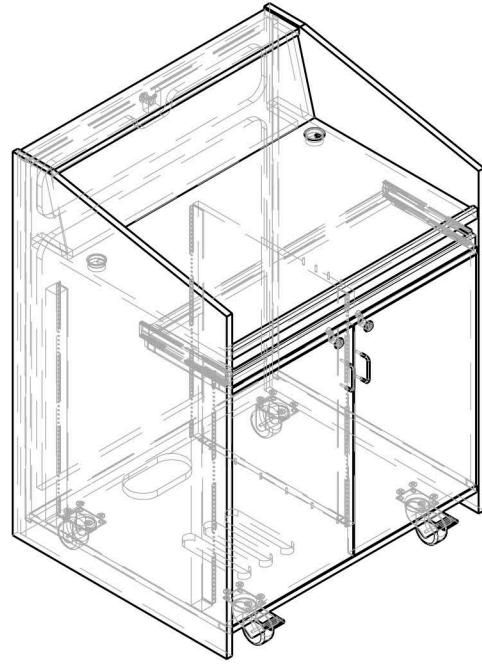

Side

(Sidepanel hidden)

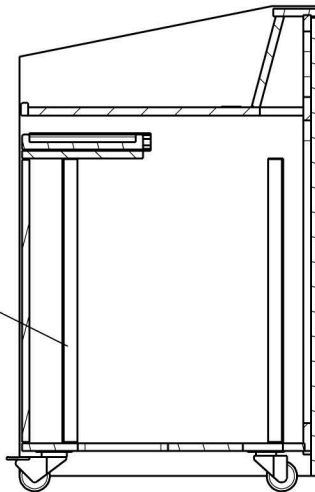

Bottom

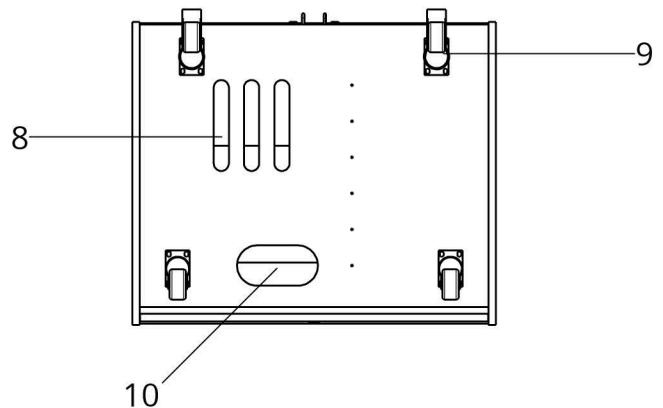

Technical Specifications

7	Installed Front/Rear Rack Rail 16RU
8	Ventilation Slots
9	HD Casters User Side Locking
10	Cable Pass