

MILLER'S

Presentation Furniture



Instructor Series 32" - Level 1
Data Sheet



MILLER'S

Presentation Furniture

Dimensions

32" W x 27" D x 48" H

Technical Specifications

1	Flat Worksurface made of P-Lam
2	Cable Grommits in Worksurface
3	Hardwood Pencil Lip
4	Heavy Duty Casters User Side Locking
5	Fixed Shelf 8" below Worksurface

Top

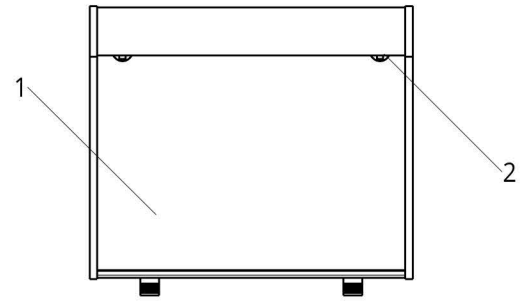

Front

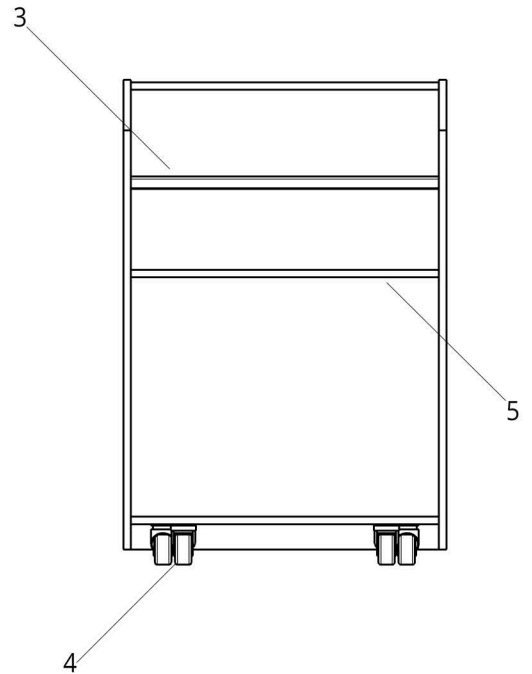

Back

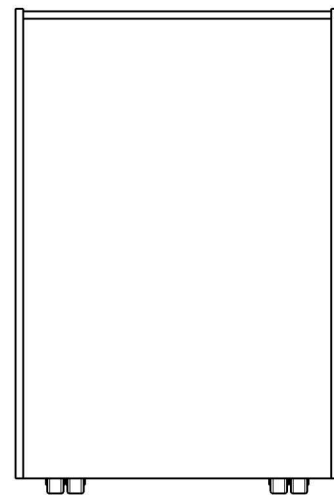



MILLER'S

Presentation Furniture

Isometric View
(Hidden lines shown)

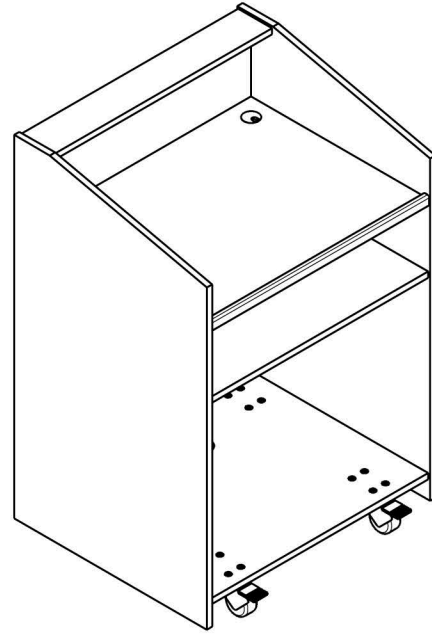

Side

(Sidepanel hidden)

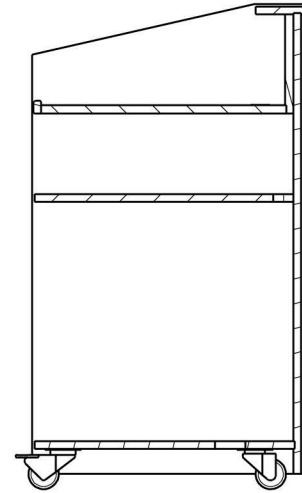

Bottom

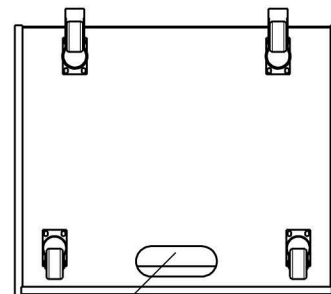

6

Technical Specifications

6	Cable Pass