

M I L L E R ' S

Presentation Furniture



Classroom Series 43.5" - WS 38"

Data Sheet



MILLER'S

Presentation Furniture

Dimensions

43.5" W x 30" D x 39" H

Rackspace: 16RU Front & 16RU Rear

Technical Specifications

1	Flat Worksurface made of P-Lam
2	Cable Grommits in Worksurface
3	Slide Out Utility Drawer
4	Slide Out Keyboard/Mouse Tray
5	Heavy Duty Casters User Side Locking
6	Locking Removable Access Panel

Top

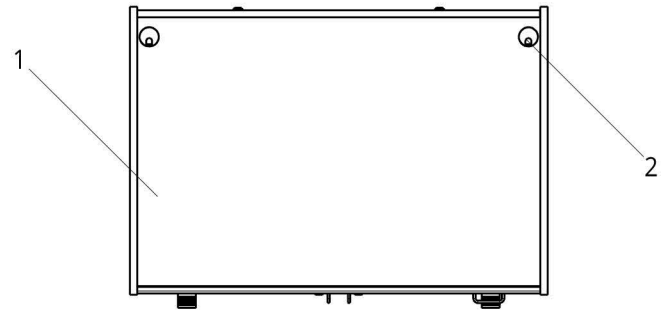

Front

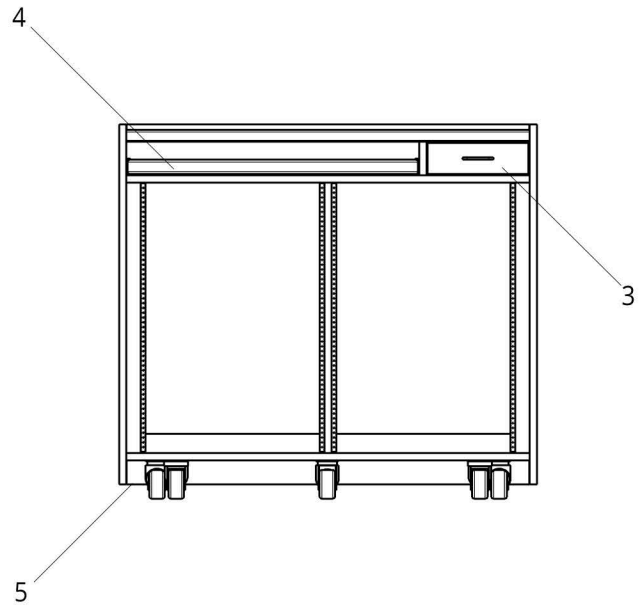

Back

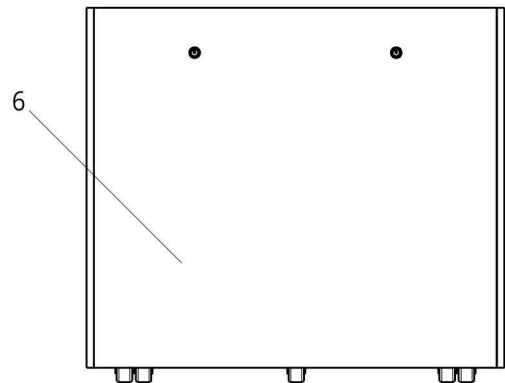



MILLER'S

Presentation Furniture

Isometric View
(Hidden lines shown)

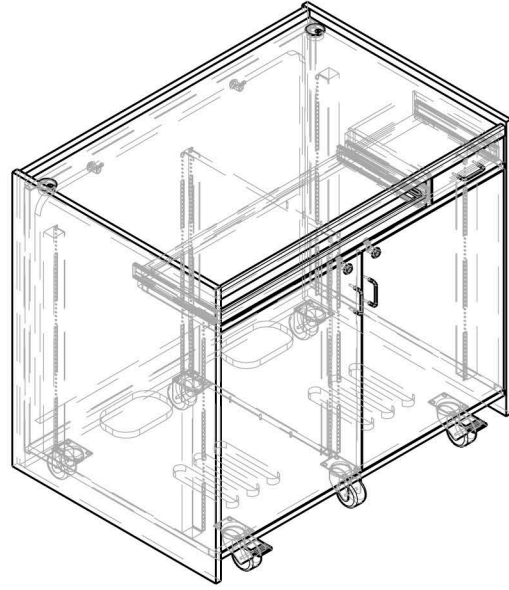

Technical Specifications

7	Hinged Locking Door
8	Ventilation Slots
9	Cable Pass

Side

(Sidepanel hidden)

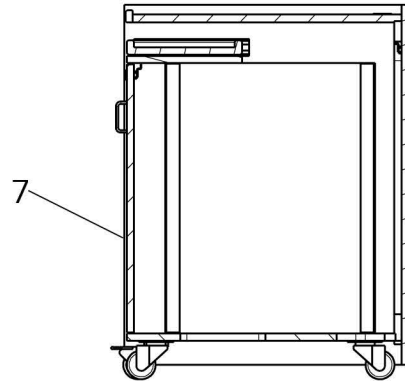

Bottom

