

M I L L E R ' S

Presentation Furniture



EDU-R13 - 13RU Rack Cabinet
Data Sheet



MILLER'S

Presentation Furniture

Dimensions

25.125" W x 26" D x 28.5" H

Rackspace: 13RU Front & Rear

Technical Specifications

1	Top of Matching Melamine
2	13RU Front & Rear Rack Rail Installed
3	Heavy Duty Casters User Side Locking
4	Utility Rail w/ Cable Grommit
5	Locking Removable Access Panel

Top

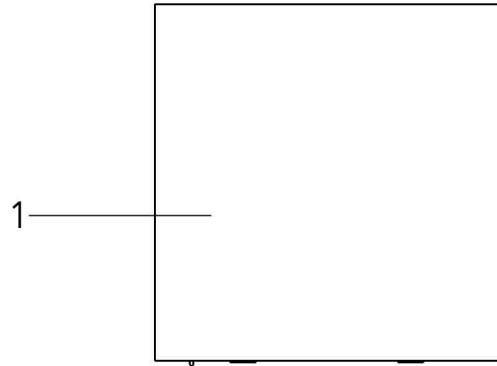

Front

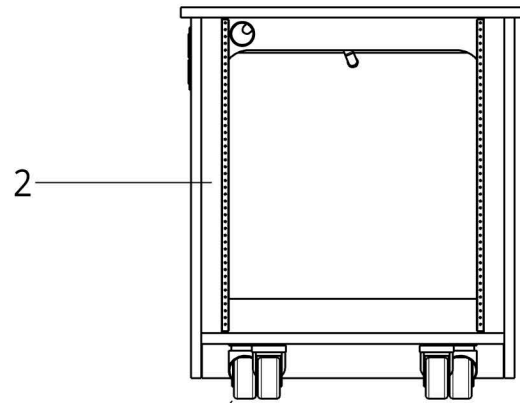

Back

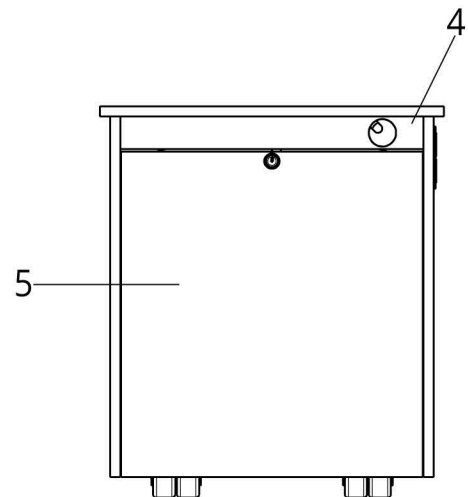



MILLER'S

Presentation Furniture

Isometric View
(Hidden lines shown)

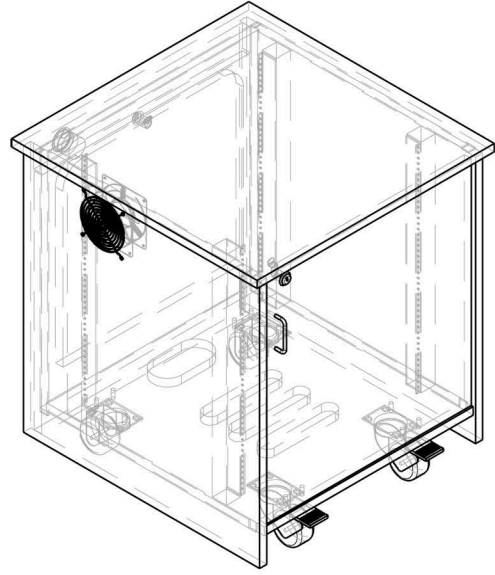

Technical Specifications

6	Hinged Locking Door
7	Quiet Fan Installed in Left Side
8	Ventilation Slots
9	Cable Pass

Side

(Sidepanel hidden)

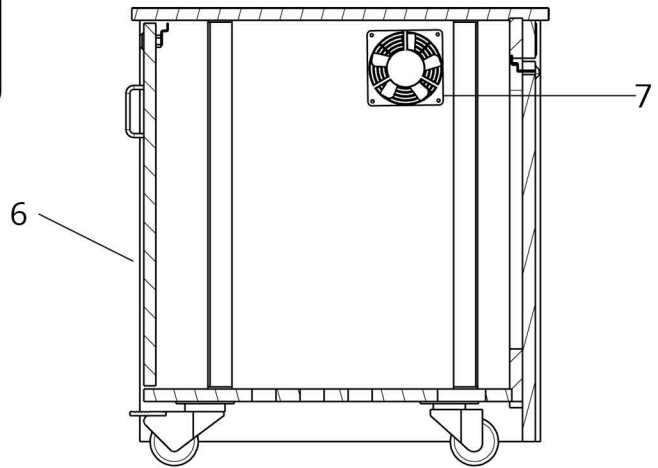

Bottom

