

M I L L E R ' S

Presentation Furniture



EDU-C3B - 3 Bay Credenza

Data Sheet



MILLER'S

Presentation Furniture

Dimensions

64.875" W x 24" D x 30" H

Rackspace: 13RU Front & Rear

Technical Specifications

1	Top of Matching Melamine
2	13RU Front & Rear Rack Rail Installed
3	Utility Rail w/ Cable Grommit
4	Locking Removable Access Panel
5	Dual Quiet Fans Installed
6	Rear Toe Kick w/ Cable Pass

Top

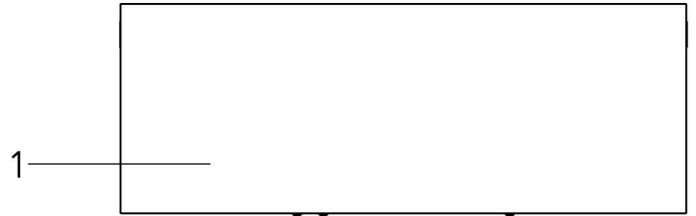

Front

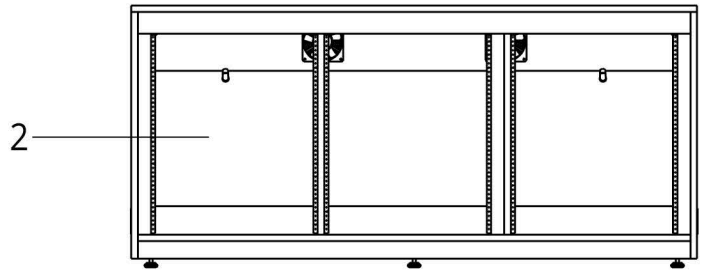

Back

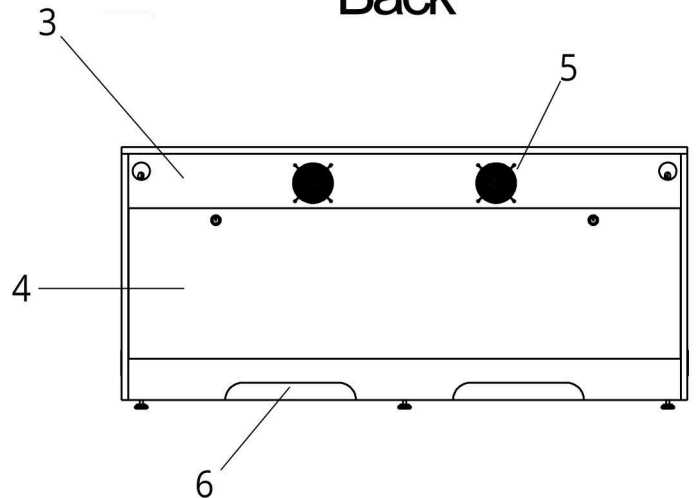



MILLER'S

Presentation Furniture

Isometric View
(Hidden lines shown)

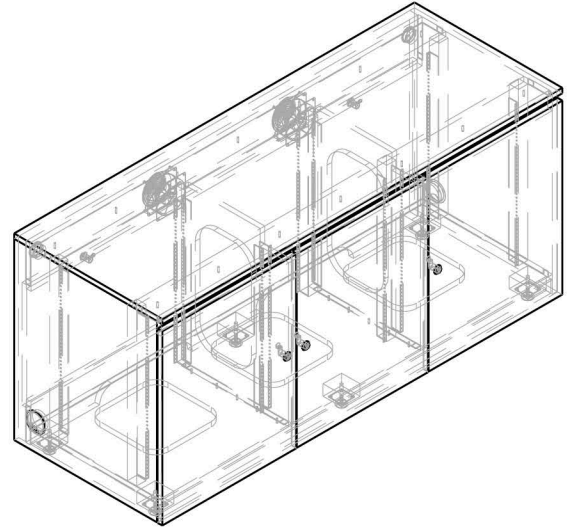

Technical Specifications

7	Hinged Locking Doors
8	Cable Grommets in both sides
9	Cable Pass
10	Leveling Legs

Side

(Sidepanel hidden)

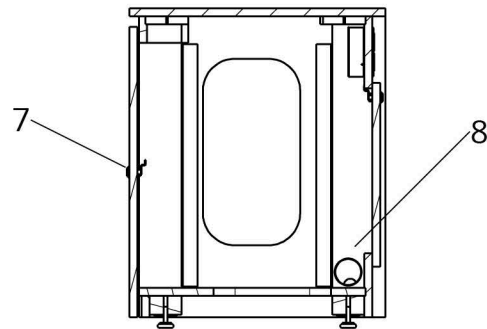

Bottom

